



2700 Series

Architectural Door Closers



An ASSA ABLOY Group brand

ASSA ABLOY



Introduction

CONTENTS

Introduction	2
Features & Benefits	3
Compliance Standards	4
Door Closing Latching Cycle	4
Finishes	5
How To Order	6
Applications.....	7
Parts	8
Accessories.....	9

2700 SERIES DOOR CLOSER

Yale® 2700 series architectural door closers are ideal for commercial applications where ease of use, installation and aesthetics are required at an economical price.

The 2700 series features rugged construction, adjustments for backcheck, closing and latch speed, rack and pinion operation and a variety of arm options.

Bringing you a dependable door closer at an attractive price point, Yale Works for YouSM.



Features & Benefits



FEATURES

- Adjustable spring sizes 1-6
- Non-handed
- Aluminum body
- Tri-packed: regular, parallel or top jamb mounting
- Full plastic cover
- Hold open and heavy-duty arms available
- Sleeve nuts furnished standard with all models
- Optional fasteners: through-bolts and grommet nuts

BENEFITS

- **Accessible:** Rugged construction allows for ease of use and installation; Tri-packed closer allows installation of multiple applications
- **Economical:** 10-year limited warranty; Longer life results in fewer replacements and less material used
- **Customizable:** Non-handed for right or left hand installation; Adjustable 1-6 spring simplifies installation; Adjustments for backcheck, closing and latch speed, rack and pinion operation; Variety of arm options



FUNCTIONS

- Backcheck
- Closing speed
- Latching speed
- Delayed action; specify 2701DL



Overview

COMPLIANCE STANDARDS

- Certified for ANSI/BHMA A156.4 Grade 1 **BHMA CERTIFIED**
- UL and cUL listed. This includes compliance to UL10C. 
- Meets requirements for Americans with Disabilities Act (ADA) and ANSI/BHMA A117.1 
- 10-year limited warranty

CAUTION: Door Closers for Low Opening Force

Applications:

Door closers installed in openings required to meet the requirements of the Americans With Disabilities Act or ANSI/BHMA Standard A117.1, when adjusted to meet those requirements, may not provide adequate closing power to dependably close and latch the door based on opening or site conditions.

DOOR CLOSING LATCH CYCLE

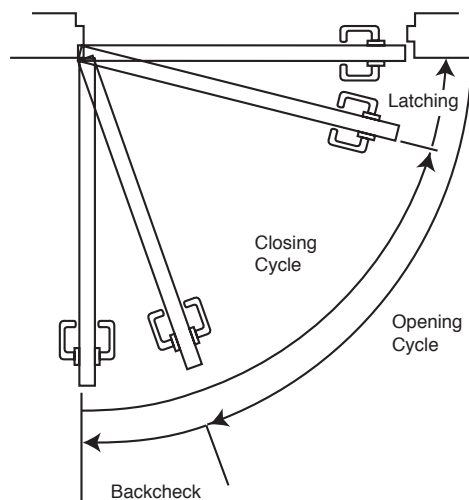

ARMS

Non-Hold Open



Self-closes door every time door is opened. Auxiliary stop (by others) required except when using the Holder/Stop arm.

Hold Open

Achieved by means of friction or ball and detent/roller. Friction hold open has a range of 90° to 180° using template location and mechanical adjustment. Ball and detent or roller hold open is effective in a range of 85° to 110°.

Hold open arm door closers are not permitted to be used on fire door assemblies.

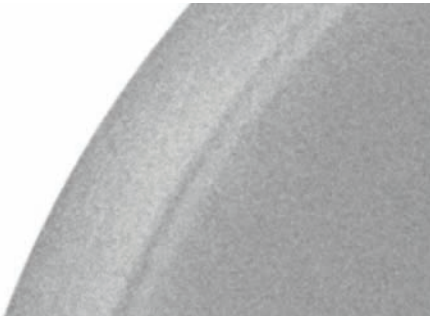
Finishes

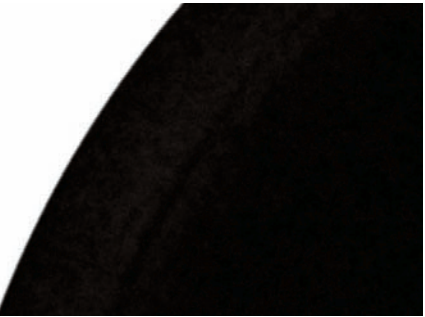
ANSI/BHMA Code Finish Description		
689 Aluminim Painted	690 Dark Bronze Painted	BSP Black Suede Powder Coat
		



How To Order

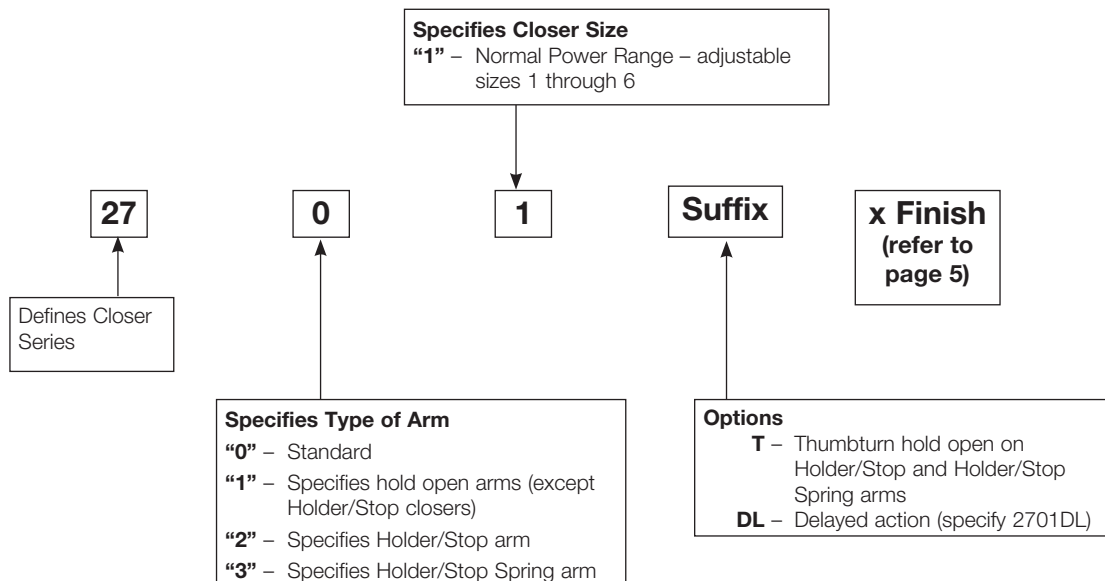

Notes:

- For heavy-duty parallel rigid arm applications, specify 2721 or 2721T, stop is removable.
- Door closer warranty becomes void if the closer is installed on the exterior side of a door in the exterior wall of a building.
- It is strongly recommended, and may be required on fire door assemblies, that doors having a door closer be hung on ball-bearing or anti-friction hinges or pivots. Consult local authority having jurisdiction.
- Failure to use fasteners supplied with closer may void factory warranty.
- Fasteners for fire/smoke door assemblies must conform to NFPA 80. In some applications additional fasteners may be mandated by NFPA 80 that are not shipped with standard Yale® product, such as sleeve-nuts/sex-nuts or thru bolts and grommet nuts.
- Information provided is based on 1-3/4" (44mm) x 7' (2.13m) standard weight doors swinging to 110°. Other conditions (such as door height or weight; or wind/draft conditions) may require adjustment of spring setting, selection of a larger size closer or different closer.

Applications

Regular Arm

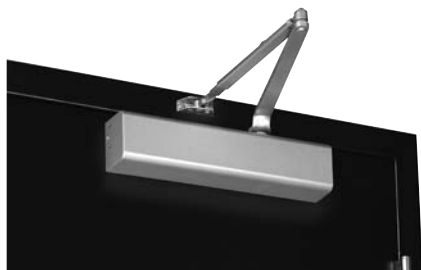

Non-hold open arm shown, hold open application available.

- Pull side application; double lever arm
- Sufficient frame, door and/or ceiling clearance must be considered
- Due to arm projection, application may present an aesthetics issue or be prone to vandalism

Top Jamb



Non-hold open arm shown, hold open application available.

- Push side application
- Sufficient frame face and/or ceiling clearance must be considered
- 2-1/4" (57mm) top rail on door is required
- Best door control for doors in exterior walls that swing out of building
- Consideration must be given to depth of reveal

Parallel Arm

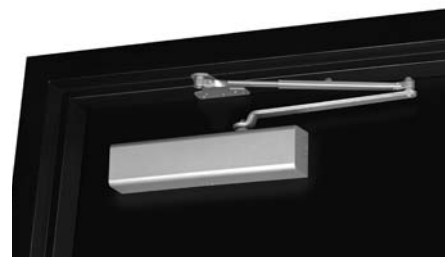

Non-hold open arm shown, hold open application available.

- Push side application
- In the closed position, there is little or no hardware projection beyond the frame face
- Due to arm geometry, approximately 25% less power-efficient than regular arm application
- Closer and arm mounted below the frame stop

Holder/Stop Arm



2721T (hold open) shown

- Holder/Stop arms incorporate a stop at the arm's soffit plate to dead stop the door at a predetermined degree of door swing between 85° and 110°, in 5° increments
- Prior to dead stop, backcheck slows the door speed to reduce the stop action
- Arm is intended for use where an auxiliary door stop cannot be used and low to moderate abuse is anticipated
- Stop is removable to allow for additional applications where auxiliary door stops are installed

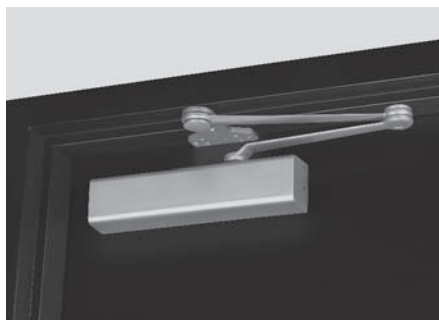

2721 (non-hold open, without stop) shown

- Holder/Stop Spring arms incorporate a buffer spring that provides greater protection at the end of the door opening cycle.
- Spring is removable

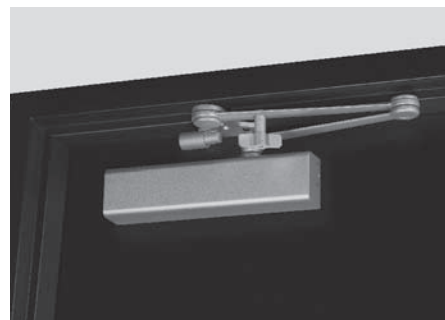

2731T (hold open with thumbturn and spring) shown

Consult factory if door weight exceeds 225 lbs.



Model/Part Numbers

Complete Units	
Model Number	Description
2701	Non-Hold Open Tri-Packed
2701DL	Non-Hold Open Tri-Packed with Delayed Action
2711	Hold Open Tri-Packed
2721	Heavy-Duty Non-Hold Open Parallel Arm with Removable Stop
2721T	Heavy-Duty Hold Open Parallel Arm with Thumbturn and Removable Stop
2731	Heavy-Duty Non-Hold Open Parallel Arm with Spring and Removable Stop
2731T	Heavy-Duty Hold Open Parallel Arm with Thumbturn and Spring and Removable Stop

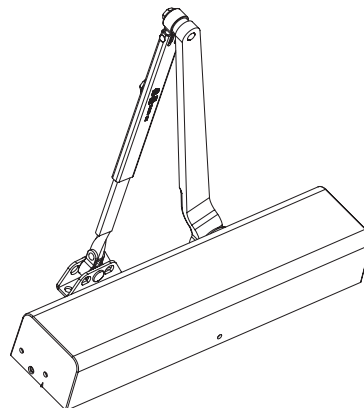

Note: for heavy-duty parallel rigid arm applications, specify 2721 or 2721T, stop is removable.

See page 6 for more how to order info.

Miscellaneous Parts*	
Part Number	Description
2700COV	Full Plastic Cover
2700SP	Screw Pack
2730Kit	Door Saver Spring Stop



2730Kit

*Specify finish when ordering.

Optional Fasteners	
Part Number	Description
TBGN134-38	Through-Bolts & Grommet Nuts

Note: Sleeve nuts furnished standard with all models.

Cover Dimensions		
Width	Length	Projection
2-7/8" (73mm)	13" (330mm)	2-1/8" (54mm)

Accessories

BRACKETS FOR NON-HOLD OPEN ARMS & HOLD OPEN ARMS

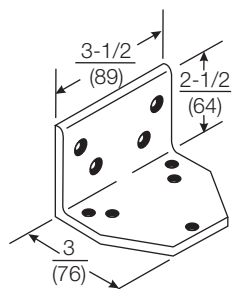

Flush Rabbeted Transom - 293L Angle Bracket: For use where flush transom conditions prevent mounting of the standard soffit plate. This bracket is used in combination with the standard soffit plate. Not for use with heavy-duty arms.

CLOSER MOUNTING PLATES

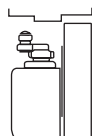
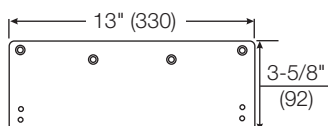

Narrow Top Rail - 3148 Drop Plate: For use where a narrow top rail prevents the closer from being mounted directly to the door surface. This drop plate can be used to mount a closer on a top rail as narrow as 2-7/16" (62mm) in height.

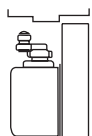
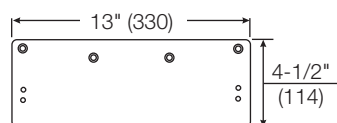

Exposed Back/Narrow Top Rail - 3158 Molded Full Cover Drop Plate: For use on doors with glass lights where a closer with molded full cover is installed and the back of the closer is exposed. This covers the back of the installation and gives a pleasing appearance from the reverse side.



Notes



Notes

Contact Us

The world's favorite lock



U.S.A.

Yale Locks & Hardware

Address: 225 Episcopal Road
Berlin, CT 06037-4004
Tel: 1-800-438-1951
Fax: 1-800-338-0965
yalelocks.com

Canada:

ASSA ABLOY Door Security Solutions Canada

Address: 160 Four Valley Drive
Vaughan, Ontario L4K 4T9
Tel: 1-800-461-3007
Fax: 1-800-461-8989
assaabloy.ca

International:

ASSA ABLOY Americas International

Tel: 1-905-821-7775
Fax: 1-905-821-1429
assaabloyai.com

Yale Commercial is a business associated with ASSA ABLOY Access and Egress Hardware Group, Inc., an ASSA ABLOY Group company. Copyright © 2012-2020, ASSA ABLOY Access and Egress Hardware Group, Inc. All rights reserved. Reproduction in whole or in part without the express written permission of ASSA ABLOY Access and Egress Hardware Group, Inc. is prohibited. Patent pending and/or patent www.assaabloydss.com/patents.

YALE, with its unique global reach and range of products, is the world's favorite lock.

ASSA ABLOY is the global leader in door opening solutions, dedicated to satisfying end-user needs for security, safety and convenience.

42821-6/20