

2000R Series EXIT DEVICE

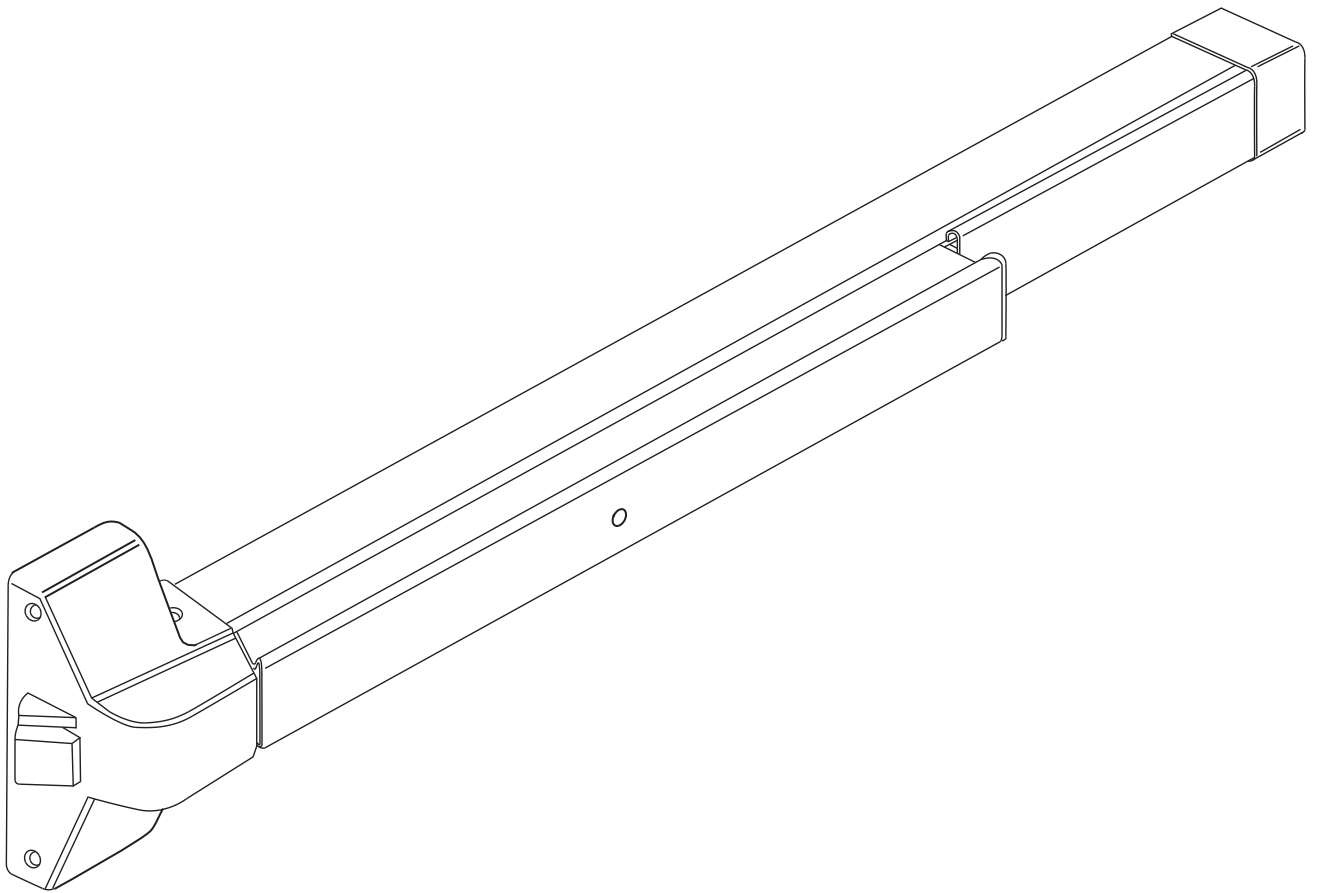

INSTALLATION INSTRUCTIONS

A IDENTIFICATION OF PARTS

IF DOOR IS LESS THAN 36", REMOVE END COVER AND CUT SECTION "A" TO DESIRED LENGTH.

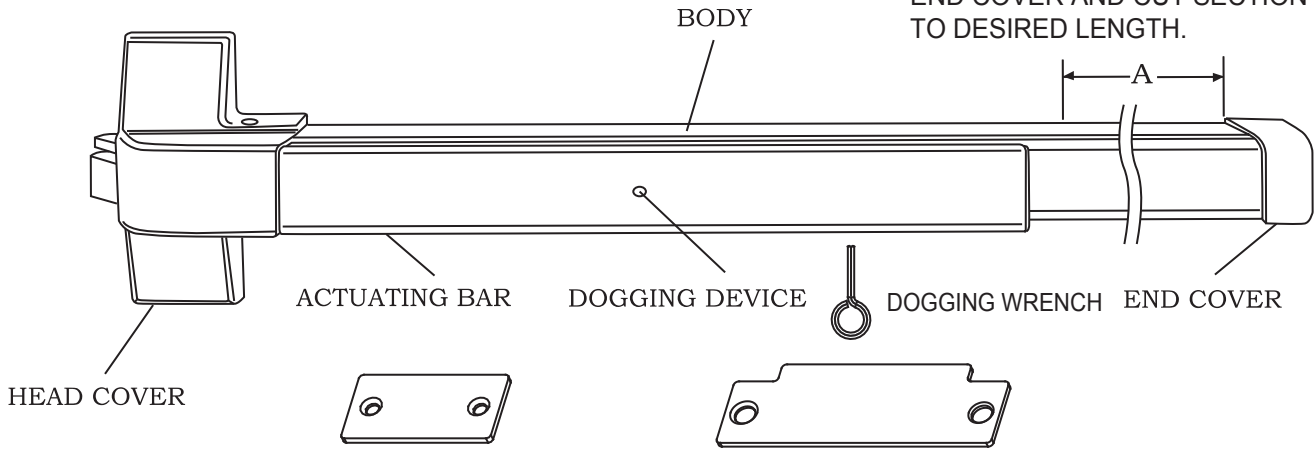

LATCHBOLT FILLER PLATE

ASA FILLER PLATE

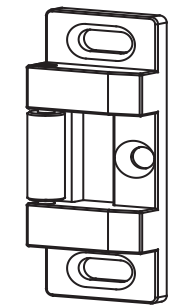

ROLLER STRIKE

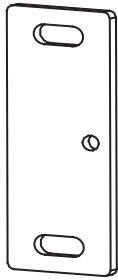

STRIKE SHIM

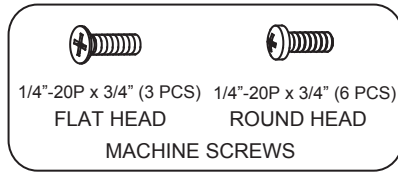

1/4"-20P x 3/4" (3 PCS) FLAT HEAD MACHINE SCREWS
1/4"-20P x 3/4" (6 PCS) ROUND HEAD MACHINE SCREWS



END COVER MOUNTING BRACKET



1/4"x1 1/2" (9 PCS) SELF TAPPING MACHINE SCREWS

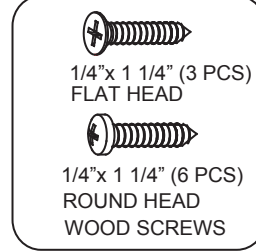

1/4"x 1 1/4" (3 PCS) FLAT HEAD WOOD SCREWS
1/4" x 1 1/4" (6 PCS) ROUND HEAD WOOD SCREWS

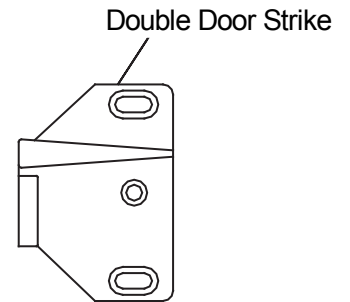

(Not Included-Must be ordered separately)
(for use on Rim x Vertical Rod applications)

B TYPE OF INSTALLATION

A. SINGLE DOOR

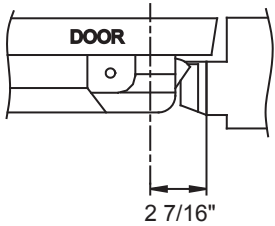

B. DOUBLE DOOR WITH MULLION

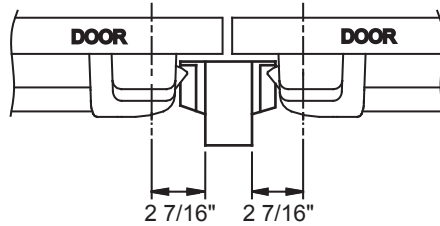

C. DOUBLE DOOR WITHOUT MULLION

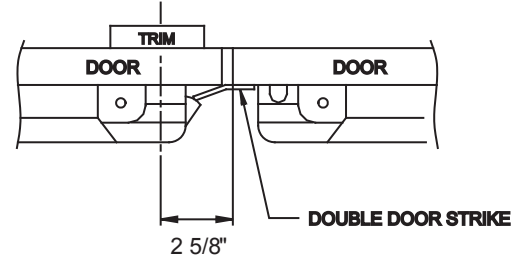

(When installing Rim Exit device and Vertical Rod Exit devices on a pair of doors, a Double Door Strike (DDS) is required. (Available by special order). For complete template information, please refer to the DDS template.

C DRILL HOLES

1. USE ENCLOSED TEMPLATE TO MARK INSIDE DOOR FACE AND DRILL HOLES IN ACCORDANCE WITH THE DIAMETERS SUGGESTED.
2. "B" LENGTH SHOULD BE MEASURED FROM THE CENTER OF THE CYLINDER HOLE TO THE END OF THE EXIT DEVICE BODY

Note: If outside trim is being used, make sure to drill holes for outside trim first and install trim, then drill holes for Exit device and install.

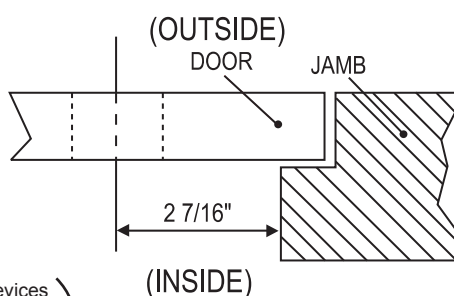

INSIDE FACE OF THE DOOR

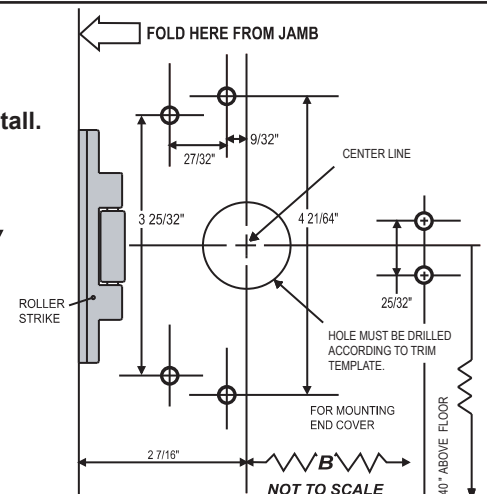

INSIDE FACE OF THE DOOR

(When installing Rim Exit device and Vertical Rod Exit devices on a pair of doors, a Double Door Strike (DDS) is required. (Available by special order). For complete template information, please refer to the DDS template.

D INSTALL CYLINDER

If required or skip to step E

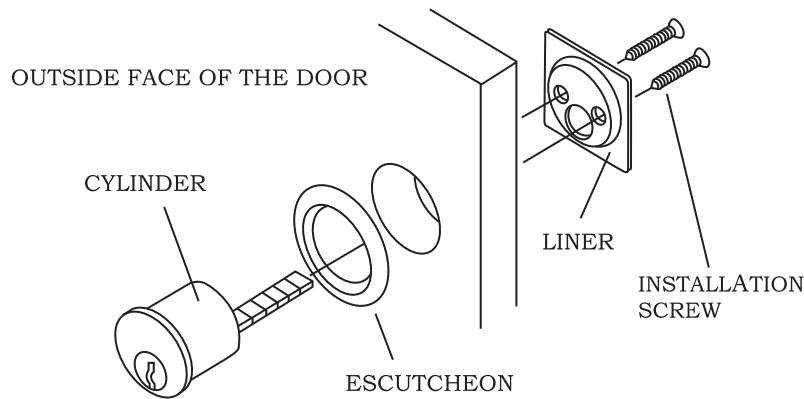

1. INSERT THE CYLINDER INTO THE HOLE ON THE DOOR
2. KEEP THE TAILPIECE HORIZONTAL
3. TIGHTEN THE SCREWS

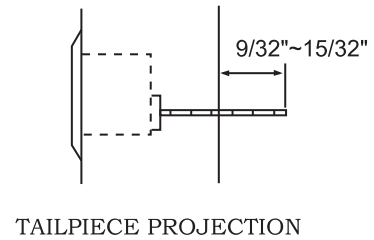

E INSTALL BODY

1. REMOVE THE HEAD COVER FROM THE DEVICE BODY AND END COVER FROM THE MOUNTING BRACKET BY REMOVING THE SCREWS THAT HOLD THEM ON.
2. ALIGN TAILPIECE RECEIVER OF EXIT DEVICE AND TRIM/CYLINDER TAILPIECE SO IT SLIDES ONTO TRIM/CYLINDER TAILPIECE, ALSO ALIGN SCREW HOLES ON EXIT DEVICE HEAD WITH MOUNTING HOLES ON THE DOOR.
3. INSTALL AND TIGHTEN THE MOUNTING SCREWS FOR THE HEAD OF THE EXIT DEVICE AND END COVER MOUNTING BRACKET

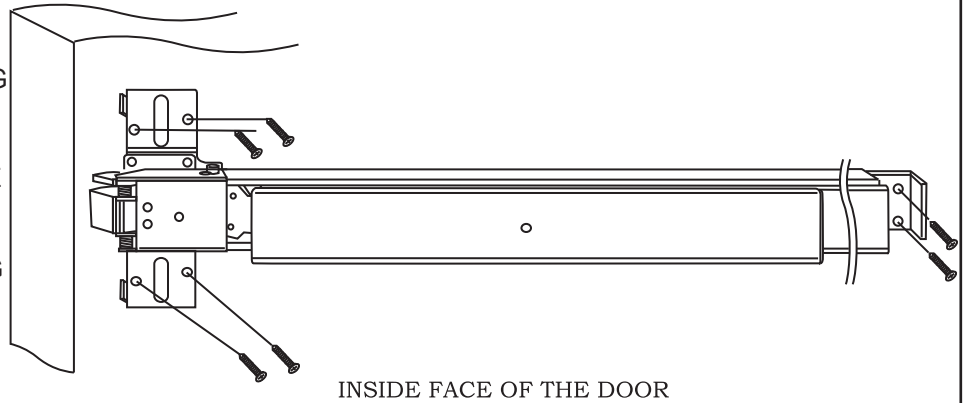

F PUT ON BOTH HEAD AND END COVER

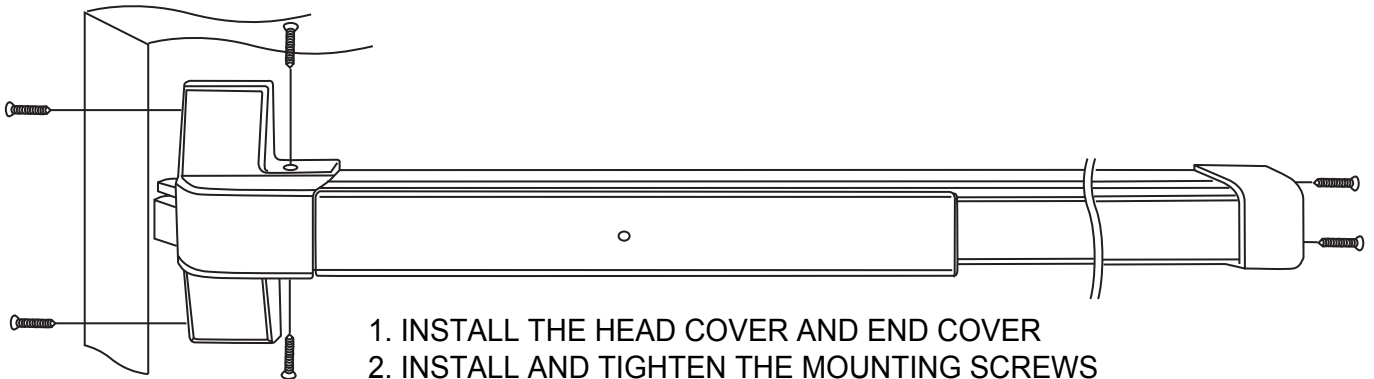

G INSTALL ROLLER STRIKE

1. WITH THE DOOR IN THE CLOSED POSITION MARK THE CENTERLINE OF LATCHBOLT ON DOOR JAMB.
2. PLACE ROLLER STRIKE ON DOOR JAMB. ALIGN CENTER OF ROLLER STRIKE WITH THE LATCHBOLT CENTERLINE MARK ON THE JAMB. THEN ALIGN THE OUTSIDE EDGE OF THE ROLLER STRIKE WITH THE OUTSIDE EDGE OF THE DOOR JAMB.

3. MARK THE CENTER OF THE 2 ADJUSTABLE SLOTTED HOLES AND DRILL 7/32" PILOT HOLES. TAP PILOT HOLES WITH 1/4"-20 THREADS AND INSTALL MACHINE SCREWS, OR, DRILL 3/16" PILOT HOLES FOR INSTALLING SELF TAPPING MACHINE SCREWS OR WOOD SCREWS IN PILOT HOLES. CLOSE DOOR TO CHECK IF LATCHBOLT EXTENDS PROPERLY. ADJUST ROLLER STRIKE IF NECESSARY.

4. WITH ROLLER STRIKE IN FINAL POSITION, DRILL A 7/32" PILOT HOLE FOR THE CENTER MOUNTING HOLE. TAP PILOT HOLE WITH 1/4"-20 THREADS AND INSTALL MACHINE SCREW, OR DRILL 3/16" PILOT HOLES FOR INSTALLING SELF TAPPING MACHINE SCREW OR WOOD SCREW IN PILOT HOLE.

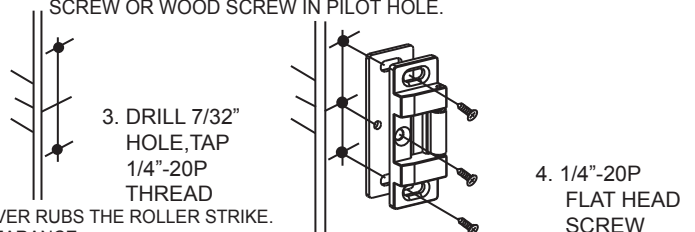
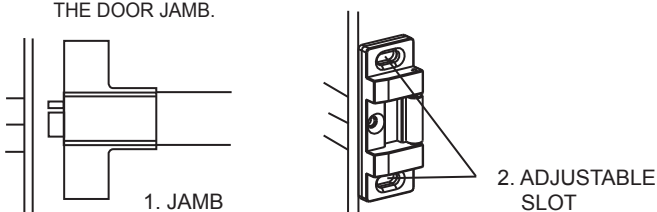

NOTE: INSTALL STRIKE SHIM UNLESS THE EXIT DEVICE HEAD COVER RUBS THE ROLLER STRIKE. THEN REMOVE THE STRIKE SHIM TO GAIN ADDITIONAL CLEARANCE.

4. 1/4"-20P FLAT HEAD SCREW

H OPERATION TEST

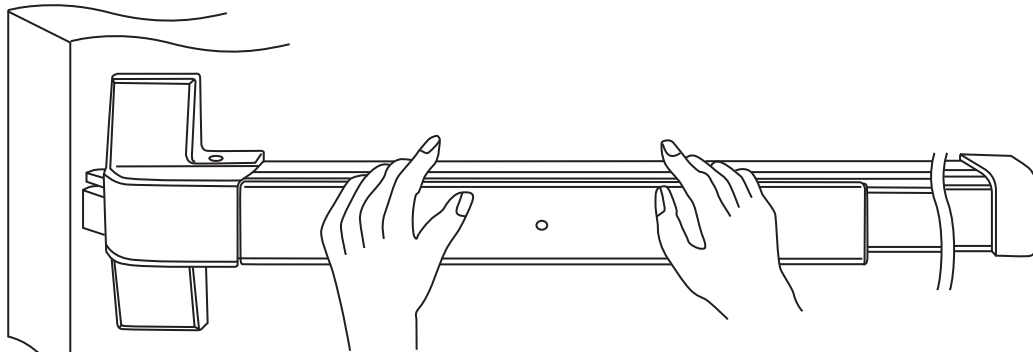

AFTER INSTALLATION IS COMPLETE PRESS DOWN THE ACTUATING BAR TO MAKE SURE THE DOOR OPENS AND CLOSES/LATCHES CORRECTLY. MAKE ANY ADJUSTMENTS AS NEEDED.

NOTICE:

TO EXTEND THE LIFE OF THIS PANIC DEVICE, LOCK THE LATCH IN THE RETRACTED POSITION WHEN DOOR IS IN CONTINUOUS USE.

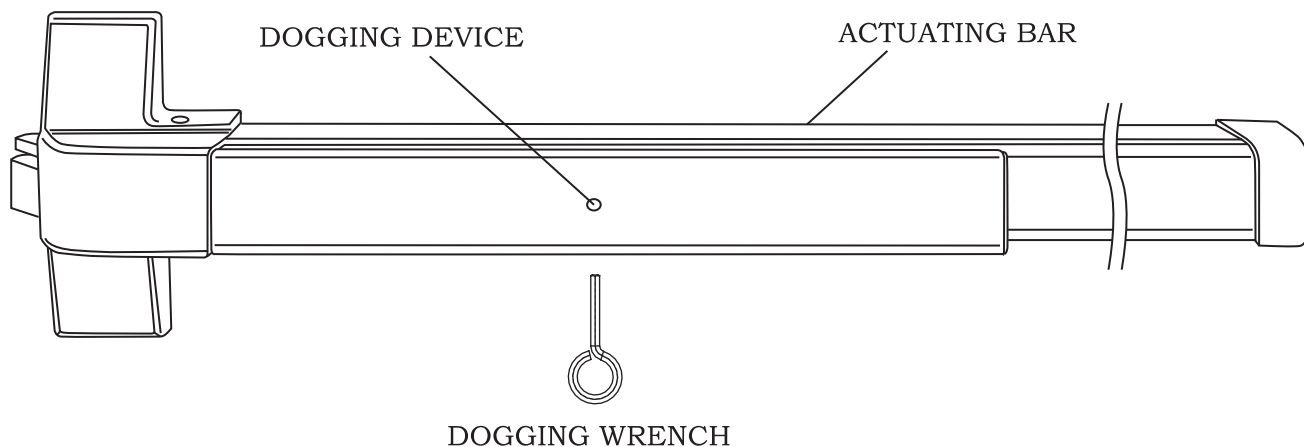

TO LOCK

HOLD ACTUATING BAR DOWN. TURN DOGGING DEVICE COUNTER CLOCKWISE WITH DOGGING WRENCH.

TO UNLOCK

HOLD ACTUATING BAR DOWN. TURN DOGGING DEVICE DEVICE CLOCKWISE WITH DOGGING WRENCH.

TEMPLATE FOR INSTALLING PANIC EXIT DEVICE

FOLD HERE FROM JAMB

2012.03

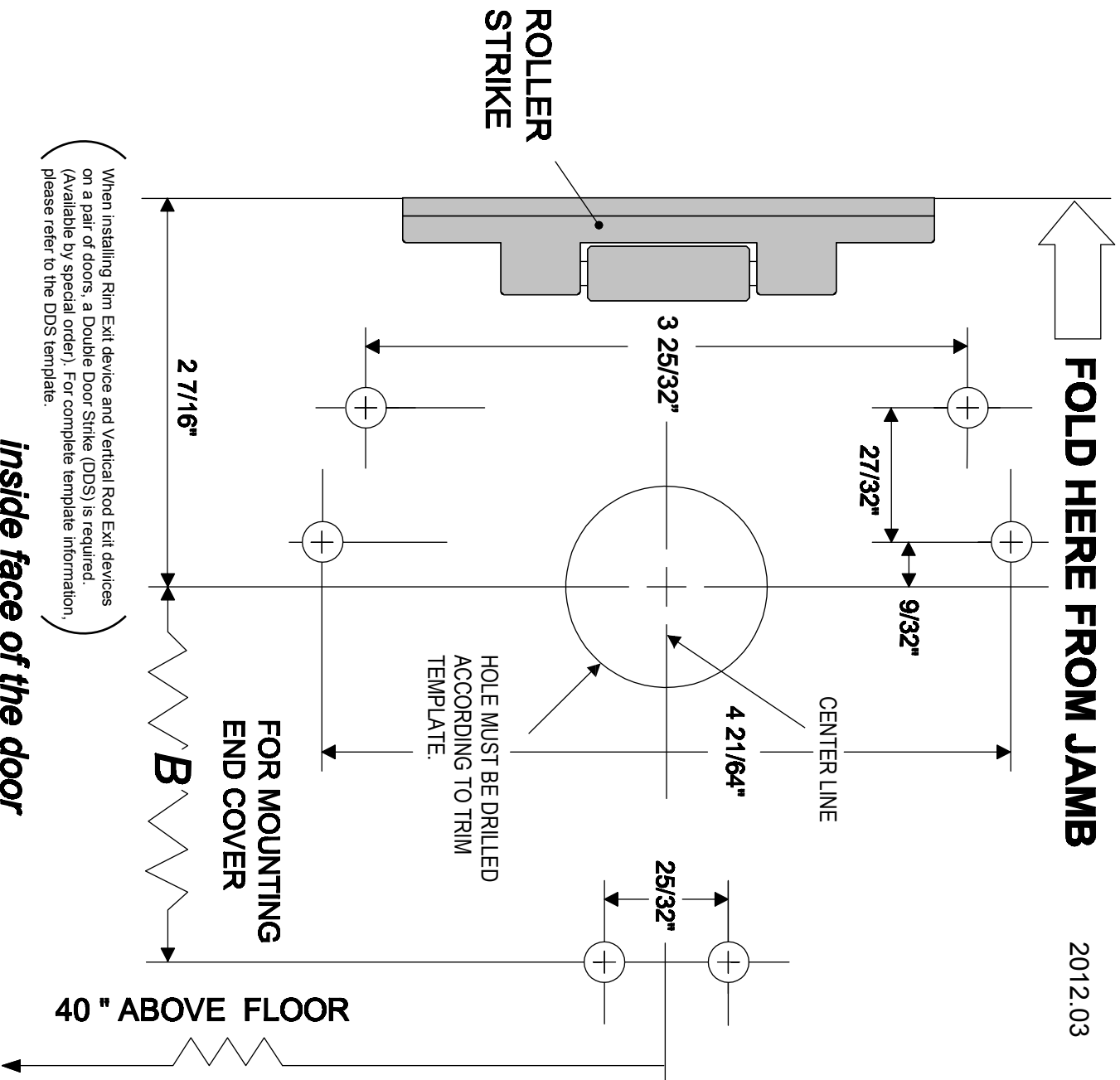
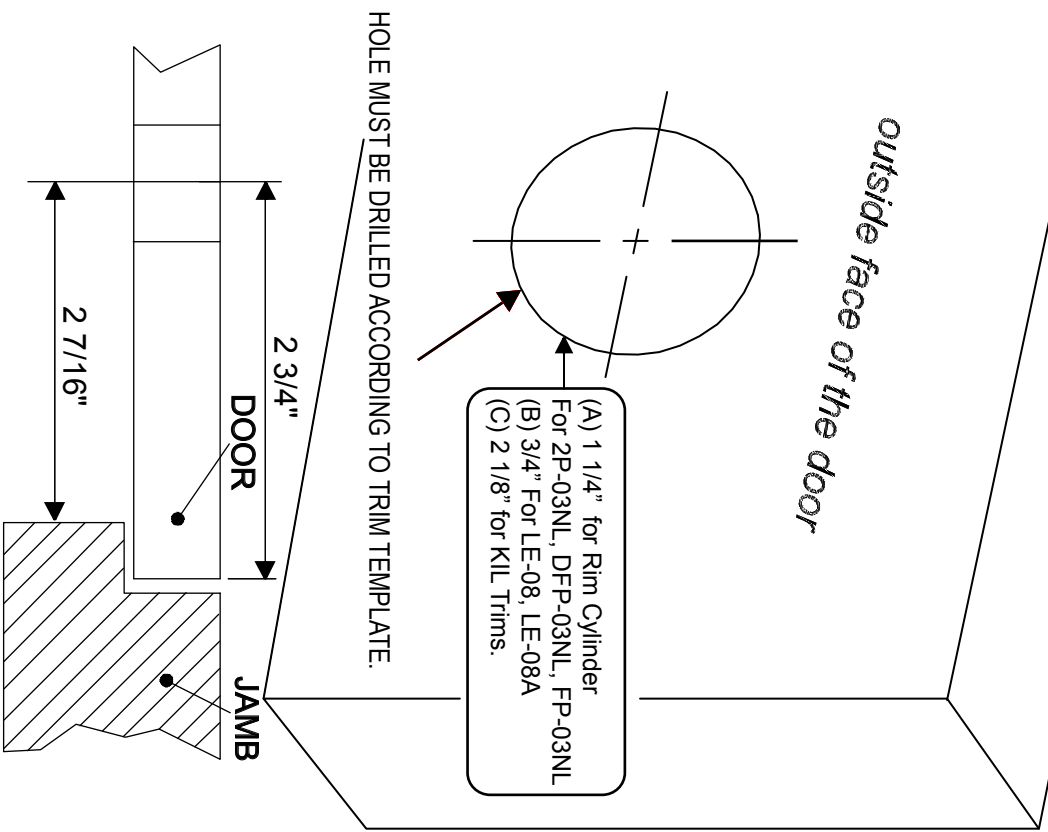

When installing Rim Exit device and Vertical Rod Exit devices on a pair of doors, a Double Door Strike (DDS) is required. (Available by special order). For complete template information, please refer to the DDS template.

inside face of the door

- (A) For 2000R Series (UL Listed)-Drill & tap for (6) 1/4"x20 machine screws for Exit Device and Drill & tap for (3) 1/4"x20 machine screws for Roller Strike
OPTIONAL for 2000R (UL Listed)
Drill (6) 3/16" Pilot Holes for Self Tapping machine screws or wood screws for Exit Device and
Drill (3) 3/16" Pilot Holes for Self Tapping machine screws or wood screws for Roller Strike
- (B) For F2000R (Fire Rated)-Drill 9/32" holes inside and 3/8" holes outside for the (6) thru bolts and drill & tap for (3) 1/4"x20 machine screws for Roller Strike.